



OPERATION MANUAL

Applicable product model:

GL-U-2M

CONTENT

1. Introduction	1
2. Precautions for safe operation	2
3. Precautions for use	5
4. Product diagram and overview	6
5. Preperation before use.....	7
6. Display panel function instruction	9
7. Defrost ●Unused ● Maintenance.....	13
8. Trouble shooting	14
9. Performance Indicators	15
10. Specifications.....	16

1. Introduction

Thank you for choosing Glacier's bio-medical products. Read this manual carefully before using the appliance and follow the instructions for the safety operation. Keep this manual in an adequate place to refer to it as necessary.

Glacier never guarantee any safety if the appliance is used for any objects other than intended use or used by any procedures other than those mentioned in this manual. The contents of the manual will be subjected to change without notice due to the improvement of performance or functions. Contact Glacier sales representative or agent if any point in this manual is unclear or if there are any inaccuracies. No part of this manual may be reproduced in any form without the expressed written permission of Glacier.

- ◆ Please read the page4-page7 carefully as it contains the important safety notices.
- ◆ Only trained or authorized personnel could operate this Ultra-low temperature freezer.
- ◆ Only qualified service personnel or authorized agent could install and maintenance this device.
- ◆ Use Glacier spare parts as always. If users want to use other accessories, Glacier bio-medical will not be responsible for the adverse consequences. However users could apply for verifying the eligibility of these accessories from Glacier before use them.
- ◆ Should inspect and maintenance the device in a specified time interval.
- ◆ Due to the differences between each models and the improvements of products, actual product may differ from the diagram. Please refer to the final product.
- ◆ Everyone has an obligation to be responsible for his or her own safety.
- ◆ Put on dry gloves when you take out refrigerated articles from the freezer.
- ◆ contents or the inside walls with naked hands may cause frostbit.

Handling frozen.

- ◆ contents or the inside walls with naked hands may cause frostbit.



Please wear gloves while handling samples to avoid injury!











After each item is accessed, be sure to dry the water stains around the inner door frame and seal to prevent freezing.





Friendly reminder

- Always use protective equipment (including clothing, gloves, goggles, etc.) correctly.
- Always adopt good hygiene.
- Everyone is responsible for his/her own safety.

2. Precautions for safe operation

For the first time to use this device, users must read the meaning of the following warning labels very carefully. Items and procedures are described so that you can use this unit correctly and safely. If the precautions advised are followed, this will prevent possible injury to the user and any other person.

 WARNING. Failure to observe WARNING signs could result in a hazard to personnel possibly resulting in serious injury or death.	 CAUTION. Failure to observe WARNING signs could result in injury to personnel and damage to the unit and associated property.
 CAUTION HOT. The sign inform the users about the danger of burns for high temperature.	 DANGER OF EXPLOSION. The sign inform the danger of the application of volatile, explosive chemical substances.
 NO TILTING.	 STAY OUT OF SUN.
 BEWARE OF ELECTRIC SHOCK! Dangerous voltage may cause personal injury! Please disconnect the power supply before repair.	 GROUNDING MARK.
 NO TRAMPLING EQUIPMENT.	 NO TUMBLING TRANSPORT PACKAGES.
 PRECISION INSTRUMENTS.	 HANDLE WITH CARE.
 THE CONTENTS MUST BE PLACED AT THE ARROW.	 FEAR OF THE RAIN.
 NO STACKING.	 NO CLAMPING.

 WARNING. Failure to observe WARNING signs could result in a hazard to personnel possibly resulting in serious injury or death.
 As with any equipment that uses CO2 gas, there is a likelihood of oxygen depletion in the vicinity of the equipment. It is important that you assess the work site to ensure there is suitable and sufficient ventilation. If restricted ventilation is suspected, then other methods of ensuring a safe environment must be considered. These may include atmosphere monitoring and warning devices.
 Do not touch any electrical parts such as the power supply plug or any switches with a wet hand. This may cause electric shock.
 Only qualified engineers or service personnel should install the unit. The installation by unqualified personnel may cause electric shock or fire.



Be sure to install the unit on a sturdy floor. If the floor is not strong enough or the installation site is not adequate, this may result in injury from the unit falling or tipping over.



Carefully with the power cord to avoid short circuit or open circuit. When removing the plug from the power supply outlet, grip the power supply plug, not the cord. Pulling the cord may result in electric shock or fire by short circuit. Don't make the power line pack and pressed by furnish or heavy goods. Also please don't close to the compressor and heat source.



Please insert the power plug firmly to avoid leakage.



Use a power supply outlet with ground (earth) to prevent electric shock. If the power supply outlet is not grounded, it will be necessary to install a ground by qualified engineers. Don't lengthen the line randomly. If you need, To use 2.5mm² copper line, you should keep 4mm² line to connect the electrical outlet. Or may cause fire.



Make sure a dedicated power source is used as indicated on the rating label attached to the unit. Out of the rate, should install a property transformer and a proper voltage stabilizer for securely operation. Or the freezer may be damaged, and may cause injury.



Be sure to install the unit on a sturdy floor, no shaking and tilting.



Never install the unit in a flammable or volatile location. This may cause explosion or fire.



Never install the unit in a humid place or outdoor or a place where it is likely to be basked straightly. Deterioration of the insulation may result which could cause current leakage or electric shock.









Do not place the device lateral tilt, do not impact the device; the device is equipped with refrigeration systems, roll or shock will easily damage the freezer.











Be sure to install the device in a dry dust-free environment to avoid overheating, short circuit and other dangers.



If there is an unexpected sound, smell, smoke when the power is turned on, unplug the power and contact the manufacturer or supplier. Continued abnormal operation may cause electric shock or fire.

	Make sure a dedicated power source is used as indicated on the rating label attached to the unit. Out of the rate, should install a property transformer and a proper voltage stabilizer for securely operation. Or the freezer may be damaged, and may cause injury.
	Make sure to put the freezer in a dry and ventilated environment, to ensure that equipment vents and wall surface of the instrument or other items have not been blocked; Do not use the device in a poorly ventilated environment, or the equipment may be damaged by the release of heat.
	Never disassemble, repair, or modify the unit yourself. Any such work carried out by an unauthorized person may result in fire or injury due to a malfunction. Meling will be no responsible for such work.
	Use this unit in safe area when treating the poison, harmful or radiate articles. Improper use may cause bad effect on your health or environment.
	Never ground the unit through a gas pipe, water main, telephone line or lightning rod. Such grounding may cause electric shock in the case of an incomplete circuit.
	Use a power supply outlet with ground (earth) to prevent electric shock. If the power supply outlet is not grounded, it will be necessary to install a ground by qualified engineers.

	CAUTION. Failure to observe WARNING signs could result in injury to personnel and damage to the unit and associated property.
	Ultra-low temperature freezer is not available to store living things, flowers, or other critical articles which is not suitable for low temperature storage.
	The temperature inside the freezer is very low during the normal working. Do not touch the interior surface of the chamber or the object inside without wearing protective gear.
	Always disconnect the power plug when the unit is not used for long periods.
	Make sure to prepare a safety check sheet when you request any repair or maintenance for the safety of service personnel. Be sure to check set point of the controller prior to restart the freezer.
	The ultra-low temperature freezer is a storage device, not a production equipment!
	Always hold the handle when closing the door. This will reduce the likelihood of a trapped finger.
	Keep the key properly avoiding the children take it to open the door which may result in unexpected injury.



Select a level and sturdy floor for installation. This precaution will prevent the unit from tipping. Improper installation may result in water spillage or injury from the unit tipping over.



Check the filter mentioned in this manual and clean it as necessary. A dusty filter may cause temperature rise or failure.



Do not tilt the unit more than 45 degrees when moving the unit. All transportation should be carefully.

3. Precautions for use

- ◆ When the freezer is running, the front part of the freezer may get hot. This is not a malfunction: In order to prevent dew condensation around the case body, a heated anti-condensation tube is installed in the cryogenic storage case.
- ◆ Before putting the items in the freezer, please make sure the temperature inside the box has reached the set temperature, and then put the items in batches. Add no more than 1/3 of the container volume each time, in case the temperature rises too much.
- ◆ The temperature display value shows the temperature of temperature sensors inside the freezer. Although the displayed temperature may sometimes differ from the actual temperature in the center of the freezer, it will get close to the real temperature gradually.
- ◆ A through-hole is installed on the right or back of the freezer to allow test lines to exit the test box. After drawing out the test lines, be sure to re-plug the test hole with insulating material, otherwise the temperature inside the box will not be completely lowered, resulting in condensation around the outside of the hole.
- ◆ Clean the freezer with diluted neutral detergent. Do not use brushes, acid, gasoline, soap, polish or hot water to clean the frozen storage container, as these materials may damage the painted surfaces and plastic rubber components.
- ◆ After a period of operation, a layer of frost will form on the inner wall and the inner door. If the frost layer is too thick, it will affect the insulation effect of the freezer and increase the power consumption. Therefore, after a period of time, when the frost layer reaches about 5mm, it should be defrosted with the defrost shovel attached.
- ◆ Please remove the frozen items in the freezer and put them in a suitable storage environment before defrost, so as to avoid the damage of goods for temperature rise.
- ◆ There are many cooling coils on the back and side of the inner wall. Don't use sharp objects such as knives, ice chisel, or screwdrivers to remove the frost on the inner wall. Be careful not to scratch the inner wall when defrosting, otherwise it will cause a failure of the freezer .
- ◆ Cut off the power when the refrigerated storage box will not be used for a long time.

4. Product diagram and overview



The main structure: consisting of the cabinet, door body, refrigeration system, control system and accessories.

Product Scope: Suitable for low temperature storage items such as medical institutions, epidemic prevention stations, research units, factories, etc.



Note: Due to the improvement of the product and the model, the actual product may differ from the sketch, please refer to the actual product! The diagram is only used to identify features! (The picture above is GL-U-2M)



Note: Before using the freezer, clean the water stains in the cabinet, especially the door seals, to prevent the door from freezing when the temperature is low, which makes the door difficult to open!



Note: The cover plate inside the ultra-low temperature freezer can be effectively insulated. When using this series of freezer, please cover the cover tightly!

5. Preparation before use

- Please read this manual carefully when using this machine for the first time.
- Ultra-low temperature storage and handling: lifting should be done from the bottom and the inclined plane should not be more than 45 degrees.
- Remove all packaging components (including protective foam in the case).
- Please check the random attachments and materials according to the packing list.
- The product should be cleaned before use.

Operating environment requirements:

Indoor use

- installation surfaces must be fixed, horizontal, non-combustible and able to withstand the weight of ultra-low temperature refrigerated storage boxes
- it should be placed in a place away from direct sunlight and heat source. The ambient temperature should not be higher than 32°C
- the requirements of more than 30cm left around the space for ventilation and heat dissipation
- it should be placed in the environment of 16~32°C
- do not place in a wet or splashing place
- no electromagnetic interference around, electromagnetic interference will affect the normal operation of the control system, serious will directly damage the system.

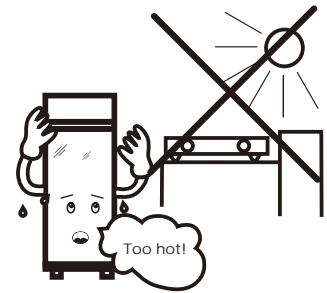

Normal working conditions:

- Ambient temperature: 16°C ~ 32°C
- Relative humidity: ≤80% RH
- No strong vibration and corrosive gas around
- No direct sunlight and other cold and heat sources

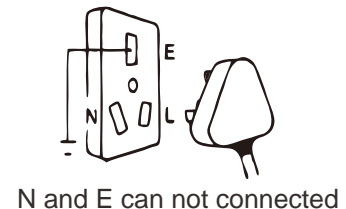

Working mechanism of the Ultra-low temperature freezer: intermittent operation

Installation site requirements

This unit is a precision machine. When select a location to install this unit, keep the following conditions for perfect performance :

- Should not be installed in a small confined space, the door of the room should not be less than height of the present equipment.
- Install the unit on a sturdy floor to avoid excessive vibration and noise.
- Installing the unit in direct sunlight may cause malfunctioning and may shorten the life of the unit. Keep good ventilation is necessary.
- Do not share a socket with other equipment, plug and socket should be securely connected.
- Socket inputs should be connected to circuit protection facilities, such as: An air switch which the rated current is bigger than 45A.
- If an extension cord is needed, be sure to use copper wire more than 2.5mm . The cross-sectional area of the copper wire inside the wall connected with the power outlet must also be more than 4mm².
- Checking the working voltage of the place before start the freezer. A voltage stabilizer is suggested to be used at the place where the voltage is not stable. Make sure the normal input voltage stable at 115V ± 10% or 208V± 10%, Power of voltage stabilizer should be more than 4KW.

-
- Be sure to ground the unit.
 - Grounding prevents electric shock which occurs when the electrical insulation of the unit becomes insufficient.
 - If the power cord socket is equipped with grounding wire, check the connection before use.
 - If the power supply outlet is not grounded, it will be necessary to install a ground by qualified engineers.



WARNING.

Do not ground the frozen storage tank through gas pipes, water supply pipes, telephone lines or lightning rods, which may cause electric shock.

After installation, the power plug must be at your fingertips to facilitate unplugging the power cord in an emergency.

No items should cover the vents of the freezer.

6. Display panel function instructions

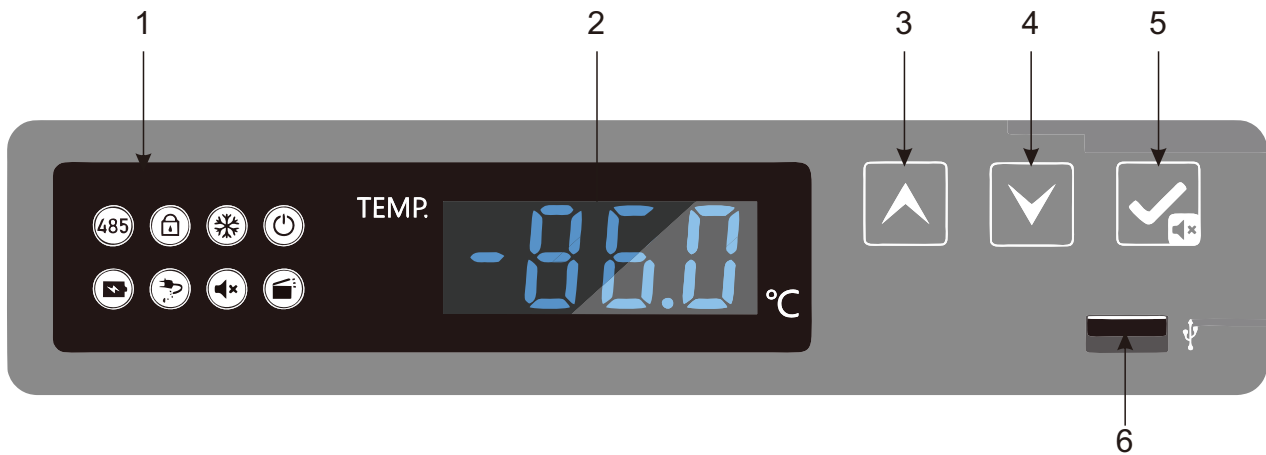

6.1 The functions represented by each indicator light: (as shown in the table on the right)

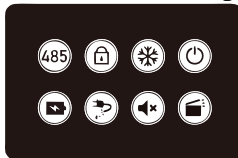

Serial port	Key lock	Defrosting	Power supply
Dump energy	Power off	Mute	Door switch

a. Serial port indicator light

When the freezer is not connected to the reserved RS-485 serial port, the serial port indicator light is off; when the freezer is successfully connected to the reserved RS-485 serial port, the serial port indicator light is on.

b. Key lock indicator light

When the keys are in the locked status, the keys will not respond, and the key lock light will be on. At this time, press and hold the up key + down key for 3 seconds, it will prompt to input the password, the default password is “005”. After inputting the password correctly, press the setting/mute key, the key lock will be disabled and the key lock indicator light will be off. If no key is pressed for 60s in the unlocked status, the key lock will be enabled, and the key lock indicator light is on. Press and hold the up key + down key for 3s, the keys will be locked.

c. Refrigeration indicator light

If the compressor is in the operation status, the refrigeration indicator light will always be on; if the compressor is in the shutdown status, the refrigeration indicator light will be off.

d. Power supply indicator light

When the indicator light is on, it indicates that the product power supply is enabled.

e. Low battery indicator light

When the battery voltage is lower than 10.8V, the buzzer will sound, the low battery indicator light will be on, and the Nixie tube will blinking display the low battery code “PL” alternately at a 3s interval; when the battery voltage is greater than 12V, the buzzer will become mute, the low battery indicator light be off and the Nixie tube resume normal display.

f. Power failure indicator light

The freezer is normally powered at a voltage of 220V. When the input power is disconnected, the buzzer will sound, the Nixie tube will blinking display the power failure code “Pf” alternately at a 3s interval and the power failure indicator light be on. When the input power is connected, it will resume normal and the power failure indicator light become off.

g. Mute indicator light



When the alarm tone key is muted, the indicator light will be on; when the alarm tone mute function is disabled, the indicator light will be off.

h. Door switch indicator light





When the door is open, the door switch indicator light will be on; when the door is closed, the door switch indicator light will be off.

6.2  is the temperature display window, used to display the average internal temperature inside the freezer under normal operating conditions, in the unit of °C;

Ambient temperature view:

When the keys are locked, press the  key, the Nixie tube will display the ambient temperature. It will resume normal display if no key is pressed for 5 seconds or by pressing  and .

When the keys are unlocked, press the  key, the Nixie tube will display the ambient temperature. It will resume normal display if no key is pressed for 5 seconds.

Humidity view: When the keys are unlocked, press and hold  key and  key, the Nixie tube will display the humidity. It will resume normal display if no key is pressed for 5 seconds or by pressing  and .



6.3  is the up key; in the parameter setting mode, press it to move to the next parameter or increase the parameter value. For example, when setting the temperature, it may be used to increase the set temperature value. When setting the parameter value, press and hold the up key to increase the parameter value quickly. Under normal conditions, press and hold the up key for 3s to import the data of 12 months into the USB flash disk.



6.4  is the down key;

In parameter setting mode, it may be used to move to the previous parameter or decrease the parameter value.

For example, when setting the temperature, it may be used to decrease the set temperature value.

When setting the parameter value, press and hold the down key to decrease the parameter value quickly.

6.5  is the setting/mute key. When there is no alarm and the keys are not unlocked, press , it will display the ambient temperature, and will resume normal display after 5s; in the unlocked status, press  for more than 3s to enter the user menu.

When the buzzer sounds (including cabinet over temperature alarm, door open alarm, sensor fault alarm, etc.), and the keys are not unlocked, press  for the first time, the buzzer will stop sound, and it will display the ambient temperature and resume normal display after 5s (only the buzzer for this abnormal status alarm is turned off by pressing the mute key, although the fault is eliminated, the buzzer will also sound if it becomes abnormal again). Press  again, the buzzer will sound, it will display the ambient temperature and resume display of cabinet temperature and alarm status after 5s. When the keys are unlocked,  can be used as the setting key.



When the keys are unlocked, in the parameter setting mode, press this key to display the parameter value and parameter name. Press and hold it for more than 3s, it will save the setting and return to the normal interface.

6.6 USB data export (optional);

Automatic export: When the USB flash disk is connected to the USB interface, the recorder buzzer will sound once, the Nixie tube display “on”, and the PDF file of the current month and the previous month will be generated in the USB flash disk. After the data transmission is completed, the buzzer will sound once, and the Nixie tube display “End”, and resume normal display after 6s.

Note: When there is little data, the Nixie tube will not display "on" or "End".



Manual export: When the keys are not locked, the USB flash disk is properly connected, and the file has not been generated yet, press and hold the up key for 3s, the Nixie tube will display “d01”, press the up key or the down key to adjust it to “d00~d12”, press  key, the file generated this time (d00) or the file for the previous month (1-12) will be saved in the USB flash disk in the format of PDF.



Note: When the Nixie tube blinking displays “LoF”, the recorder has not been started yet; press  the and  keys for 3s, “LoF” will disappear, the buzzer sound once, and the recorder will be started.

(2) Function settings:

a. Connect the power supply and turn on the power switch on the back of the cabinet, the machine will be in the working status;







b. User parameter settings:

Unlock: In normal operation, press and hold the  and  keys at the same time for 3s, the Nixie tube will display the parameter code “000”, enter the password “005” (when entering the user menu password, enter “099” to restore the key lock password to the default “005”.) to unlock. After unlocking, press and hold  for 3s, the Nixie tube will display the parameter code “PS1” and it enter the settings to adjust the parameters.

Use the  or  key to roll the parameters. The display order is

Ps1→b1→b2→Set→H→L→n→y→r→S→F→Pt→tH1.

Press  to confirm the parameter category, the first parameter name of each category will be displayed;

- ① Use the  or  key to roll the parameters;
- ② Press the  key to display the corresponding parameter value;
- ③ Use  or  to increase or decrease the value;
- ④ Press  to temporarily store the modified value and return to the display parameters;
- ⑤ If you want to modify other parameters, repeat steps ①~④
- ⑥ Press and hold  for more than 3s to store the modified parameters and return to the display parameter category.

c. Exit the parameter setting program by pressing and holding  for more than 3s, or after no key is pressed within 60S.

2. Parameter display:

Sr.No.	Menu item	Parameter range	Default value	Remarks
1	b1	V1.0~9.9	/	Hardware version
2	b2	V1.0~9.9	/	Software version
3	Set	4.0	-80	Temperature setting
4	H	0.0~10.0	5.0	High temperature alarm set value "set+H"; when H=0, cancel the alarm, when the temperature is too high, the high temperature alarm shows H1
5	L	0.0~10.0	5.0	Low temperature alarm set value "set-L"; when L=0, cancel the alarm, when the temperature is too low, the low temperature alarm shows L1
6	Pt	0~240min	20	Print interval
7	tH1	20.0~50.0 °C	40.0	Ambient temperature alarm upper limit
8	Ps1	0000~9999	0005	User menu password setting

3. Alarm display

Alarm code	Fault description
H1	High temperature alarm
L1	Low temperature alarm
H2	High ambient temperature alarm
H3	High condenser temperature alarm
do	Door ajar alarm
PF	Power failure alarm
bL	Low battery alarm
ER	Recorder not connected (if any)
LoF	Recorder not activated (if any)
EE	Communication fault



Note: the "high temperature alarm" is a normal phenomenon when starting the machine for the first time. After the temperature in the cabinet is stable, the "high temperature alarm" will be automatically removed before putting in the goods.

Note: the storage of goods should not exceed 1/3 of the cabinet capacity each time. After reaching the set temperature and running normally for 24 hours, the goods with another 1/3 of the cabinet capacity should be put into storage.

Try not to open the door during the cooling process, or the temperature will rise.

Note: do not set the temperature frequently in a short period of time, otherwise, due to the large inertia of hot and cold, it may not reach your expected setting effect; When placing items in the cabinet, ensure that there is a certain air circulation flow space around the cabinet, especially keep off the temperature sensor hole inside the cabinet (for collecting the temperature inside the cabinet), otherwise it will affect the stability and accurate display control of the temperature inside the cabinet!

Note: do not cover the temperature sensor hole in the cabinet (use it to collect the temperature in the cabinet) for items placed in the cabinet, or it will affect the stability and accurate display control of the temperature in the cabinet!

Note: in order to give full play to the best performance of the machine, when the storage temperature range of the ultra-low temperature freezer is $-10\sim-86^{\circ}\text{C}$ and the storage temperature is below -80°C , please set the temperature at -80°C for the first time. Only after the system runs steadily at -80°C for 3~4 hours can the temperature be further reduced to -80°C !

7. Defrost •Unused • Maintenance

7.1 Defrost

- ◆ After working for a period of time, the inner surface of the ultra-low temperature freezer will be frosted, which will affect the refrigeration effect and increase the power consumption. When the frost layer is too thick, it should be defrosted.
- ◆ Defrost should first unplug the power plug, cut off the power supply, put on special protective gloves, open the door, and transfer the contents of the cabinet; use the defrosting shovel to gently remove the surface frost, which can also let the temperature inside the box rise naturally, melting the frost, then dry the defrosting water with a dry cloth;
- ◆ After the defrosting is completed, the power can be turned on and the machine can be cooled.



Note: Defrost cannot use electric heaters, metal tools, sharp sharps, etc.

7.2 Unused

- ◆ If the ultra-low temperature freezer needs to be stopped for a long time, the power supply (including the battery power supply) should be cut off, cleaned according to the method of 7.3, and opened to dry before sealing.
- ◆ Before using it again, use a dry cloth to dry the water around the liner (especially the part where the door seal is in direct contact with the cabinet) to avoid freezing the door seal at low temperatures.

7.3 Maintenance

- ◆ Cleaning the filter: Regularly clean the dust on the filter at the air inlet of the chassis to avoid affecting the heat dissipation effect. (Cleaning method: first unscrew the screw of the ventilation panel of the chassis, lay the ventilation panel flat, and then unscrew the fixing screws of the filter, use the brush Gently brush off the surface dust or rinse with tap water, dry it and refill it.)
- ◆ Clean and maintain the ultra-low temperature freezer at regular intervals. (For safety reasons, the power plug must be unplugged before scrubbing)
- ◆ Wipe the inner and outer surfaces of the ultra-low temperature freezer with a warm, damp cloth.
- ◆ When the stain is serious, wipe it with a neutral detergent for washing utensils, and then wipe the water stain with a soft cloth.



CAUTION

Note: Do not directly sprinkle water on the cabinet to avoid the insulation of the electrical components and the rust of the metal parts. Never use hot water and corrosive detergents or organic solvents to clean the cabinet.



WARNING

Children are not allowed to play games in the ultra-low temperature freezer!

8. Trouble shooting

Any product has the possibility of failure. Please observe the operation of the Ultra-low temperature freezer in the process of use. If there is any abnormality, please check and compare the errors with the following table. If you can't fix the issue, Please inform our service center in time. We will serve you wholeheartedly to avoid any losses.

Term of use: 10 years

Troubles	Reason and solutions
The unit doesn't work	<ul style="list-style-type: none"> ➤ Does the power plug have electricity ➤ The power plug is inserted or loose. ➤ Is the power fuse disconnected? ➤ Is the power supply voltage too low or too high
Compressor doesn't work	<ul style="list-style-type: none"> ➤ Temperature setting is correct or not ? ➤ Is the temperature inside the box too low?
Temperature does not reach the set value	<ul style="list-style-type: none"> ➤ Whether the door is closed or the door is open too often? ➤ Do you have too many items at one time? ➤ Is the ambient temperature too high?
Big noise	<ul style="list-style-type: none"> ➤ Is the box placed on a flat floor? ➤ Does the cabinet hit the wall?
High ambient temperature alarm	<p>➤ Reason: ambient temperature is higher than 32°C or the cabinet body is too close to the wall around, the ventilation effect is not good.</p> <p>Solution: please let the cabinet body and wall around the distance had better be more than 30 cm, and the outlet can not be blocked, often clean the filter, pay attention to the room ventilation or open air conditioning in hot summer.</p>

Note: If the malfunction is not eliminated after checking the above items, or the malfunction is not shown on the above table, contact Meling sales representative or agent.

Follows are not failure:

- There will be a slight crash sound of the compressor switch when the compressor is starting and stopping. The cooling time is longer than normal for the first use of the freezer. These are normal phenomenon.
- In the wet rainy season, there will be a little frost forming on the surface of the freezer, use the dry cloth to wipe it off will be OK.
- The twice opening of the door should after 5 minutes, otherwise the outside warm air will come in, the negative pressure inside the freezer caused by a sharp decline will make the door difficult to open.
- A sound of liquid flow inside the freezer is a normal sound of refrigerant circulating.
- Inner liner opposite of the gasket is a press release area of the freezer, will be some slight crack inside during the cold and hot temperature alternation. It is a normal phenomenon. Do not affect the regular use.
- Optional with printer, the screen flickers when the printer is printing or the screen is refreshing the data.
- The screen controller will show system abnormal sometimes when the first time to start of the freezer. It is normal due to that the controller has not completely read the data, it will back to normal after the data reading. If the controller do not show regularly for a long time, should turn off the power switch and restart it.

Please clean and disinfect the machine before notifying the maintenance engineer.

Transportation or use of the process shall not be violent vibration, collision, to prevent rain.

Storage and transportation conditions: ambient temperature: -40°C ~ +55°C, relative humidity: 10% ~ 90%.



Warning: this product is made of flammable working medium. It is strictly forbidden to disassemble and repair (especially compressor, refrigeration pipe and other related parts). If there is any fault, it must be repaired by zhongke meling service center.

9. Performance Indicators

9.1 Main Specifications

Model	Climate Type	Temp Range (°C)	Effective Capacity (L)	Rated Voltage (V~)	Rated Frequency (Hz)	Rated Current (A)	Input Power (W)	Net Weight (Kg)	External Size (D × W × H) (mm)
DW-HL50	N	-10~-86	50	220	50	4.89	1050	104	700×951×757

9.2 Package List

Name	Operation Manual	Keys	Defrost shovel
Number	1	1 × 2	1

9.3 Circuit

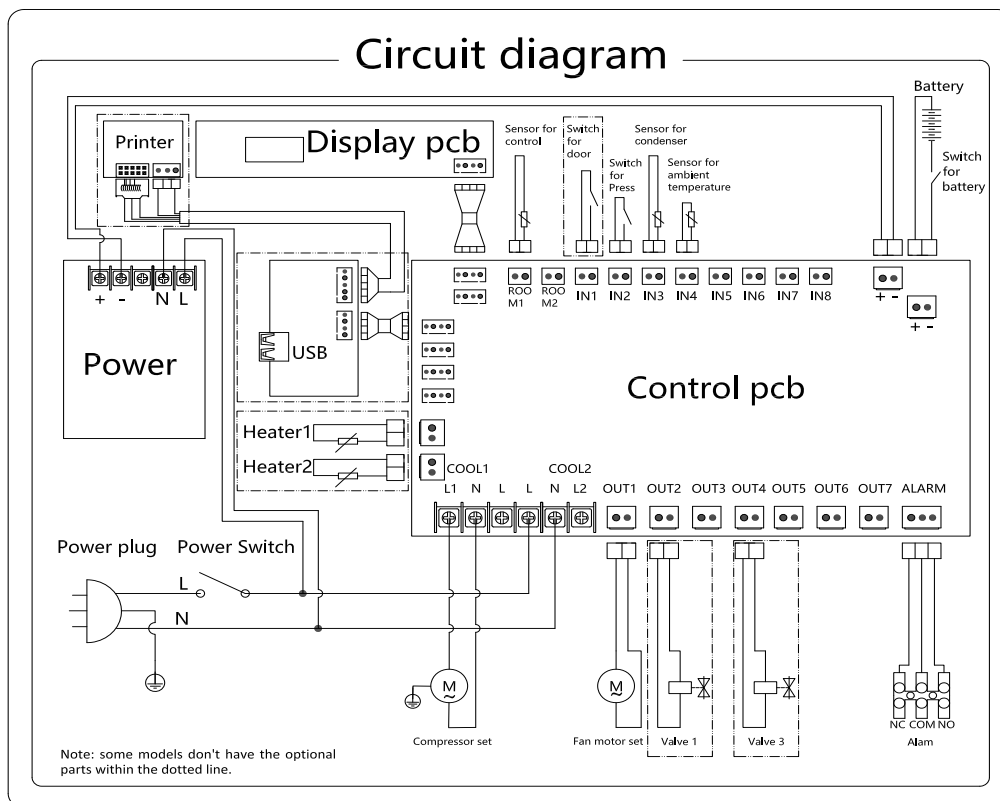

*If there is any product improvement, the technical data and electrical circuit diagram shall be subjected to the nameplate.

10. Specifications

Name	Ultra-low temperature freezer
Model	GL-U-2M
Case	Epoxy polyester powder coated steel sheet
Exterior doors	Epoxy polyester powder coated steel sheet
Insulation	Rigid polyurethane foam filling
Compressor	Fully enclosed
Refrigerant	Mixture
Thermostat	Microcomputer control system
Temperature Sensor	PT1000